

Oscillation Control in a Synchronous Machine using a Neural based PSS

Control de oscilaciones en una máquina síncrona usando un PSS neuronal

*Sandra Milena Pérez Londoño**, Juan José Mora Flórez, Alfonso Alzate

Grupo de Investigación en Calidad de Energía Eléctrica y Estabilidad (ICE³)
Programa de Ingeniería Eléctrica. Universidad Tecnológica de Pereira.
Pereira, Colombia.

(Recibido el 24 de octubre de 2007. Aceptado el 29 de enero de 2008)

Abstract

This paper presents the methodological design and the laboratory test of neural net based power system stabilizer (PSS). The architecture of the proposed PSS uses two neural networks, one neural based controller which is used to generate a supplementary control signal to the excitation system, and an additional neural net used to improve the performance of the neural based controller. In order to guarantee the correct operation of the proposed PSS, it is trained by using data obtained from several machine operating conditions and a variety of disturbances. The effectiveness is demonstrated by testing the proposed approach in a real synchronous machine in a laboratory facility.

----- *Keywords:* Power system stabilizer, neural nets, synchronous machine.

Resumen

En este artículo se presenta el diseño y la prueba en laboratorio de un estabilizador de potencia (PSS), basado en redes neuronales. La arquitectura propuesta del PSS utiliza dos redes neuronales, la primera es un controlador que efectúa un control suplementario del sistema de excitación, y una segunda red utilizada para mejorar el desempeño del controlador anterior. Para garantizar la correcta operación del PSS propuesto, éste ha sido entrenado utilizando datos obtenidos a partir de varias condiciones de operación de la máquina, y una amplia variedad de disturbios. La efectividad del método propuesto se confirma a partir de los resultados de las pruebas con máquinas síncronas utilizadas en laboratorio.

----- *Palabras clave:* Estabilizador de potencia, redes neuronales, máquinas síncronas

* Autor de correspondencia: teléfono: +57 +6 + 321 17 57, fax: +57 +6 + 313 71 22, correo electrónico: saperez@utp.edu.co (S. M. Pérez).

Introduction

The main function of the electric power system is to supply electric energy to the end customer in an efficient way. This power system is dynamic and non linear in nature and works in a changing environment. These changes may produce oscillations which in certain situations can cause instability or oscillatory performance. The power system stabilizer (PSS) is a supplementary excitation controller used to damp oscillations in the power system. Several linear and non linear control methods have been used in the PSS design, such as pole placement, state feedback, adaptive control and robust control, among others. In last years, different types of intelligent controls based on techniques as fuzzy logic, neural nets and genetic algorithms have been tested.

Since eighties neural nets (NN) has been used in control, to take advantage of its parallel and fast processing capacity and the ability to map non linear functions. This technique has been tested satisfactorily in identification and control applications in nonlinear systems [1] In the reported studies of NN based PSS, two cases are clearly identified: a) NN used to on-line tuning of parameters for conventional stabilizers (proportional, derivative and integral), where each input represents actual operating conditions of the system, and the outputs represents the stabilizer parameters [2] and b) NN used to replace the stabilizer. There also applications based in two NN, one of them works as identifier while the other performs the control task [3, 4, 5].

This paper presents the implementation of a NN based PSS, in which a single net is trained by using data from a traditional based adaptive PSS. To improve the PSS performance, a new re-training strategy is proposed considering an additional NN. The later net helps to establish the relationship between the output signal and the control signal (input), to identify the control signal required to obtain a specific output. This signal is later complemented with the output of the trained neural PSS and the plant input (field voltage), to obtain the complete PSS control

signal. Next and by using this information, the proposed controller is re-trained. This strategy improves and differentiates this proposal from other commonly referenced NN based PSS as those previously presented [3, 4, 5]. In addition, tests of the proposed neural based PSS are performed in a real laboratory system, where the synchronous machine is stressed by different perturbation situations.

Structure of the real laboratory test system

The studies of the influence of a neural based PSS here presented were performed on a real synchronous machine connected to a single node equivalent system. A schematic diagram of the test configuration at the electrical machine laboratory is shown in figure 1.

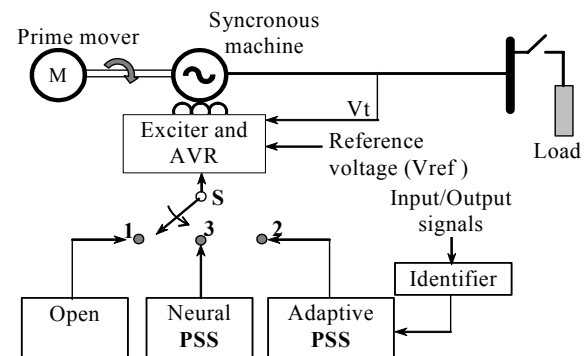

Figure 1 Test system configuration used in a machine laboratory

The system is composed by a speed controlled prime mover, which drives a synchronous generator. The field circuit is supplied by solid state exciter, composed by a semi controlled rectifier bridge, that varies its output voltage according to the value of the thyristors firing angle (α), producing changes in the field current and finally it causes variations in the generator terminal voltage. These actions are performed by the automatic voltage regulator (AVR), which is considered the expert part of the machine exciter control. During a power system perturbation, the

AVR performs actions to reestablish the normal conditions. In this work, the regulator was implemented by using the classic proportional integral methodology, adjusted to the nominal condition of the synchronous machine. The PSS is an auxiliary controller of synchronous machines, which applied over the excitation system gives control signals to improve the damping of oscillatory signals caused by machine perturbations. The PSS output gives an additional control of the exciting signal applied to the synchronous machine field [6]. In figure 1, the switch S is used to carry out tests on the system configuration without PSS (open), with Adaptive PSS and with Neural PSS (positions 1, 2 and 3, respectively). The measurements in figure 1 are variables corresponding to the terminal voltage and the active power. After conditioning, all measurements are fed to a data acquisition unit, which consists of a 16-bit PCI bus data acquisition card and a PC type computer. All data processing and software task are performed by using a PC.

**Designing a Neural Based PSS
Proposed methodology**

To design of the neural based PSS, the following stages were performed:

- a. Stage one: Adaptive PSS development
- b. Stage two: On line application of the adaptive PSS to obtain a training data set.
- c. Stage three: Neural based PSS and modifier net designing.
- d. Stage four: Neural based PSS and modifier net training.
- e. Stage five: On line application of the modifier net and the neural based PSS to obtain a new training set
- f. Stage six: Estimation of the neural based PSS desired output and new training process
- g. Stage seven: Using the re-trained based neural PSS.

Following the previously mentioned stages are described.

Stage one: Adaptive PSS development

As first step in the neural based PSS setting, it is necessary to obtain a training data set from the synchronous generator. This data set is obtained from a PSS developed by using a simple and classical technique. In case of the proposal here presented, a self tuning adaptive technique as the presented in [7] was selected. This technique was used to obtain the machine model considering a “black box” approach and propose a transfer function obtained by using input/output data [8]. This methodology is commonly known as on line identification, and includes the measurement of some electrical variables as the terminal voltage and the active power, maintaining online the power generator. By using such methodology, it is possible to obtain online the constants of the transfer function, which are not the physical machine parameters. There are also some approaches which help to obtain the physical machine parameters by using the constants of the transfer function as it is presented in [9]. In that approach, on line identification techniques where used to determine the machine transfer function. These constants are used in the adaptive control law avoiding the use of a machine mathematical model as a function of the physical parameters.

A self tuning method takes samples of current and past values of variables such as active power (P_a) and the PSS output (U_{pss}) to establish the control law according to (1).

$$U_{pss(k)} = \frac{1}{b_2} [a_2 P_a(k) + a_1 P_a(k-1) + a_0 P_a(k-2) - b_1 U_{pss(k-1)} - b_0 U_{pss(k-2)}] \quad (1)$$

Parameters a_2, a_1, a_0, b_2, b_1 and b_0 are the outputs of the identification system, obtained by using the least squares algorithm [10]. Sub indexes k are related to time sampling instants.

In figure 2, the complete adaptive PSS structure is shown. This scheme presents also the identifier scheme, whose outputs are used to obtain the control stabilizing signal (U_{pss}) as an adaptive PSS output.

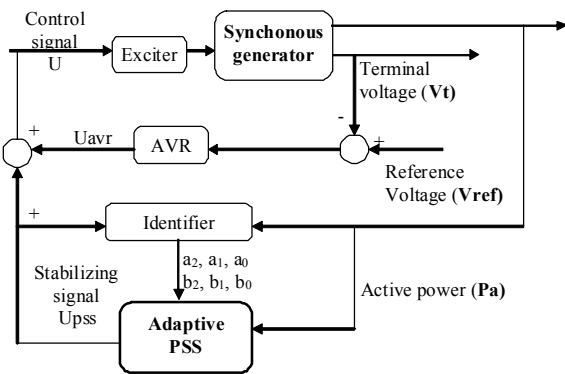

Figure 2 Adaptive stabilizer structure

The AVR output (U_{avr}) is given according to the deviation of the terminal voltage from the reference value. The control signal (U) is composed by the AVR and the adaptive PSS outputs ($U_{pss} + U_{avr}$), as shown in figure 2.

To verify the response of the proposed identifier as a consequence of a random variation of the magnitude in the field voltage, the figure 3 is obtained. Continuous line represents the power signal measured $Pa(k)$, while the dotted line is the power estimated by the identifier $Pa_{est}(k)$. Both lines overlap showing the good behavior of the identifier.

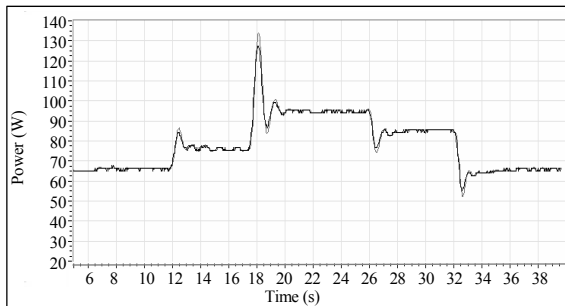

Figure 3 Power measured on machine terminal $Pa(k)$ in continuous line, and the power estimated by the identifier $Pa_{est}(k)$ in dotted line

Stage two: Online application of the adaptive PSS to obtain a training data set

Figure 4 shows the functional scheme used to obtain the training set. The data set was obtained

by having the machine working under different situations as load variation, reference voltage variation, and short circuits.

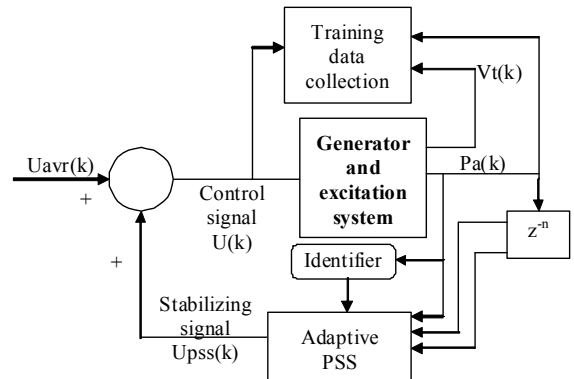

Figure 4 Functional scheme used to obtain the training set

In figure 4, control signal (U) is composed by the signal given by the AVR (U_{avr}), and the output of the adaptive PSS (U_{pss}).

The training data set is composed by the vector presented in (2).

$$[P_a(k), P_a(k-1), P_a(k-2), U_{pss}(k), U(k), V_t(k)] \quad (2)$$

$Pa(k)$ is the actual power, $Pa(k-1)$ and $Pa(k-2)$ are the two previous signal samples, $U_{pss}(k)$ is the actual output of the adaptive PSS or stabilizing signal, $U(k)$ is the system control signal and finally $V_t(k)$ is the actual terminal voltage of the synchronous machine. This training set is next used in stage three.

Stage three: Neural based PSS and modifier net design.

The basic architecture of the neural based PSS proposed, contains two neural nets. The first is known as neural PSS and it replaces the adaptive PSS. The second, known as modifier net, helps to improve the results of the first net, by determining the relation between the desired voltage terminal $V_t(k)$ and the neural PSS output $U_{pss}(k)$ which causes it.

There are two reasons to use only two layers in the proposed structure. First, in control applications, this structure has been tested and defined as the most adequate [5]. Second, the processing time is proportional to the complexity of the neural net structure and in this case it is short, because the simple structure selected.

a. *Neural stabilizer structure:* The neural net used to model the PSS, is a multilayer perceptron type, has three inputs, 15 neurons in the hidden layer, and one output. The general structure of the neural is shown in figure 5.

Active power values $Pa(k)$, $Pa(k-1)$ and $Pa(k-2)$ compose the input set, while the desired output is the control signal $Upss(k)$. A sigmoid activation function is selected for the hidden layer, while a linear function was choose for the output layer. In addition, the selection process to define the number of neurons in each layer is performed by using convergence tests, as presented in table 1 [11].

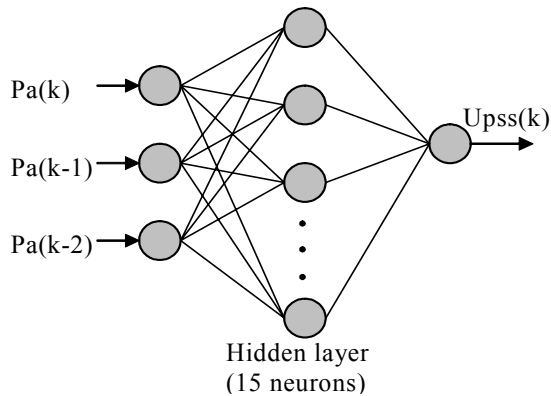

Figure 5 Proposed structure of the neural net based PSS

b. *Neural modifier net structure:* As explained before, the neural net used to adjust the neural based PSS, previously trained using data from the adaptive PSS, is known as modifier net. It is used to determine the relation between the desired output system (voltage terminal) and the neural PSS output which causes it. The modifier net has two inputs, the actual samples of active power $Pa(k)$ and the terminal voltage $Vt(k)$. The control signal

$U(k)$ is the only output. The complete structure for the modifier neural net is shown in figure 6. In this case, five neurons are used in the hidden layer.

Table 1 Network convergence

Number of neurons	Maximum error
5	0.280
8	0.200
15	0.036
18	0.090

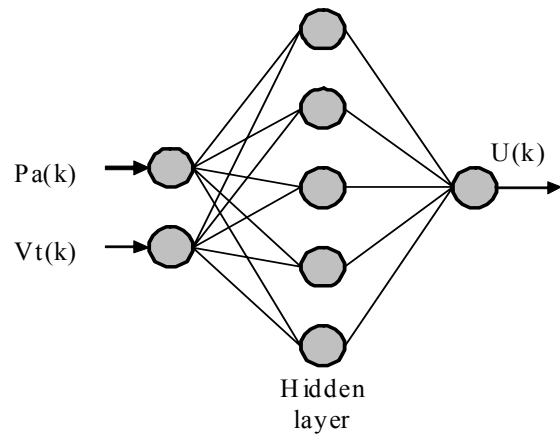

Figure 6 Basic structure proposed for the modifier neural net

Stage four: Neural based PSS and modifier net training offline

The training sets used in both neural networks are obtained from a scheme with the adaptive PSS. Training rate for both networks is 0.1 and this procedure is performed offline and following a back propagation algorithm. The error measurement used to update weights and gains is computed as the difference between the target value and the neural net output. Having trained the neural PSS, the expected performance is as near as possible as the adaptive PSS performance. Some improvements are expected, because of the learning and generalization capability of neural networks [11].

Stage five: On line application of the modifier net and the neural based PSS to obtain a new training set

Once the convergence criterion was reached for both neural nets, the adaptive PSS is replaced by the neural based PSS. Next the input $V_t(k)$ of the modifier net is replaced by the reference voltage (V_{ref}) to determine the output $V_{op}(k)$, defined as the control input signal required to force the output terminal voltage to be equal to the reference voltage. Having the two neural nets working online (Neural based PSS and the modifier neural net), as depicted in figure 8, it is possible to obtain a new set of training data $Pa(k)$, $Pa(k-1)$, $Pa(k-2)$ and $V_{op}(k)$. This new training set is used to perform a complete training of the neural based PSS.

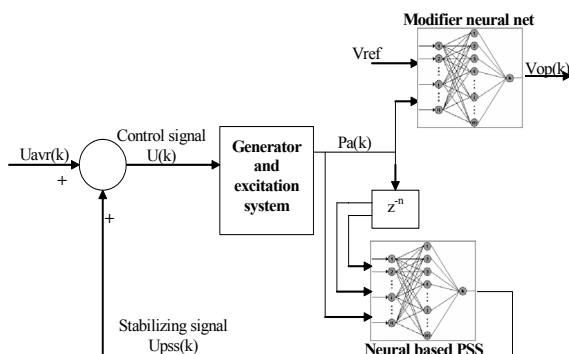

Figure 8 Basic scheme used to obtain the new training data, used to finally set up the neural based PSS.

In this step the new training data have to be obtained performing variations in the generator operating conditions as it was described before.

Stage six: Estimation of the neural based PSS desired output and new offline training process

Considering that the output of the modifier neural net (V_{op}) is the input signal to the excitation system, required to obtain the reference value. This signal is then used to obtain the desired value of the neural based PSS (U_{pss}), as it is presented in (3).

$$U_{pss \text{ desired}} = V_p - U + U_{pss} \quad (3)$$

Where U is the control signal incoming to the excitation system and U_{pss} is the output given by the neural based PSS. To obtain $U_{pss \text{ desired}}$ it is necessary to use the data previously obtained (*new training data*). Additionally, the samples $Pa(k)$, $Pa(k-1)$, $Pa(k-2)$ are used as inputs to the neural based PSS, starting the new off line training process.

Stage seven: Using the re-trained based neural PSS

Once this new training has finished, the neural based PSS is ready to be used online, as it is shown in figure 9.

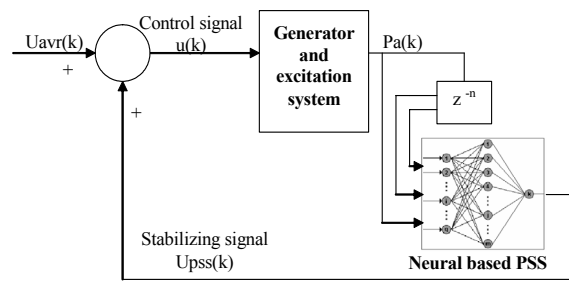

Figure 9 Final operation scheme of the neural based PSS

Experimental validation of the proposed approach

The performance of the neural based PSS has been tested for different operating conditions and disturbances of the power synchronous generator. In this paper, the results for the more representative situations are presented. Three types of disturbances have been selected: first, variations in the value of the reference voltage; second, variations in the supplied load, and finally three phase short circuits. The aim is to compare results with: a) only AVR, b) adaptive PSS and c) Neural based PSS.

Test type 1: Variations in the value of the reference voltage

Having the synchronous generator supplying active power of 0.95 p.u, lead power factor of 0.96, a sudden increase of a 10% of the reference

voltage is applied; five seconds later the reference voltage comes back to the initial reference. 15 seconds later, the voltage reference value is suddenly decreased in 10% and maintained at this value during five seconds to be returned to its initial value. The variations of the terminal voltage measured at the synchronous machine with three different schemes (system working with only AVR, with adaptive PSS and with neural based PSS) are shown in figures 10, 11 y 12, respectively.

In these tests, at five seconds when the increasing of 10% in the value of the reference voltage is applied, the following behaviour is observed: a) the terminal voltage of the generator with only AVR presents a 4% overshoot and oscillations four seconds later; b) If the adaptive PSS is used, the settling time is two seconds, and the oscillations are reduced considerably; and finally c) having a neural based PSS, it presents a three seconds settling time, but the oscillations decrease, compared to cases presented in a and b.

Later, when a 10% decrease in the reference voltage is applied at time of 15 seconds, the neural based PSS makes a soft transition and being more damped than the others.

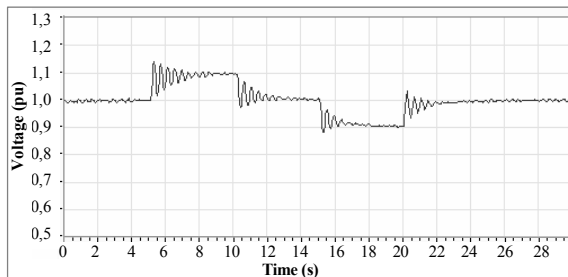

Figure 10 System response due to $\pm 10\%$ step change in the value of the reference. Terminal voltage at synchronous generator only with AVR

The output active power measured at machine terminals, during variations of the reference voltage, considering the three configurations are presented in figures 13, 14 and 15. The power variation is explained because the machine is

working connected to a single node power system and the load is impedance type.

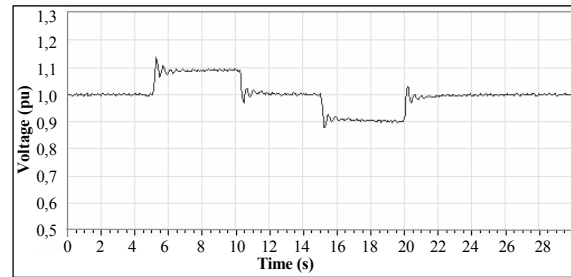

Figure 11 System response due to $\pm 10\%$ step change in the value of the reference. Terminal voltage at synchronous generator with adaptive PSS.

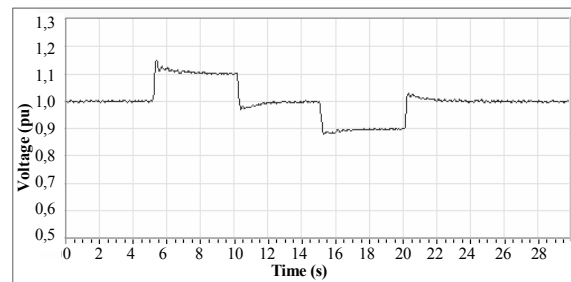

Figure 12 System response due to $\pm 10\%$ step change in the value of the reference. Terminal voltage at synchronous generator with neural based PSS

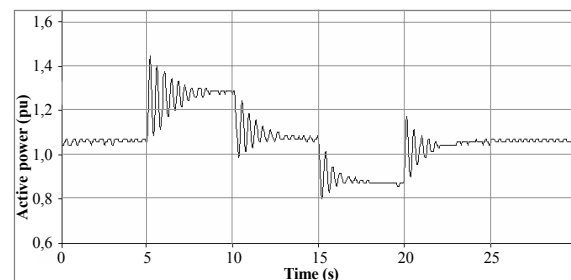

Figure 13 System response due to $\pm 10\%$ step change in the value of the reference. Terminal active power at synchronous generator only with AVR

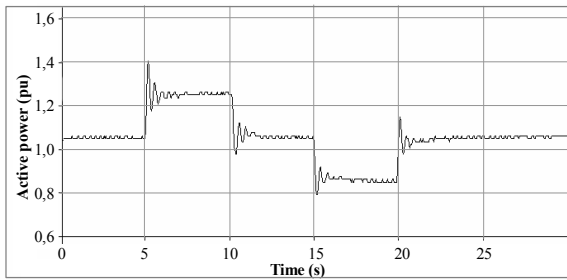

Figure 14 System response due to $\pm 10\%$ step change in the value of the reference. Terminal active power at synchronous generator with adaptive PSS

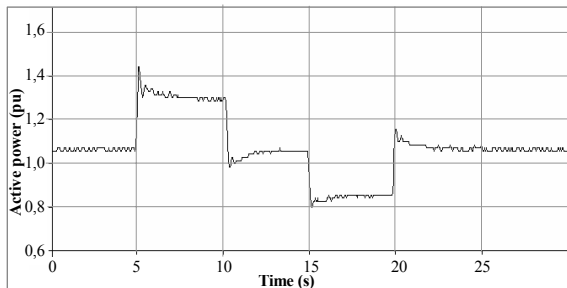

Figure 15 System response due to $\pm 10\%$ step change in the value of the reference. Terminal active power at synchronous generator with neural based PSS

Test type 2: Load variations

To determine the neural based PSS performance against other perturbation types, it has been considered to vary the connected load. During this test, the synchronous generator supplies apparent power of 0,9 p.u., power factor of 0.93 lag and terminal voltage of 1.0 p.u. At time of five seconds, the load is decreased from the state stable condition to 0.5 p.u., maintaining the power factor. Next, at time of 15 seconds the initial operating conditions are reestablished.

In this case, when power load is decreased, it produces an instantaneous increase in generator terminal voltage of about 10%. Each one of the here compared schemes, performs actions to control this abnormal value of the terminal voltage. In the case presented in figure 16, which considers only the effect of the AVR, it is shown a

high oscillatory behavior of the terminal voltage. In addition, the setting time is around five seconds. In case of the adaptive PSS scheme presented in figure 17, the oscillations are reduced and the setting time is around two seconds. Finally and considering the scheme with contains the neural based PSS, the setting time is around one second, as it is shown in figure 18.

The output active power measured at machine terminals, and considering each one of the schemes here compared, is presented in figures 19, 20 and 21. According to these figures, at time of 15 seconds, the differences are better appreciated. Having the scheme with AVR, the system presents oscillations; however when the neural based PSS is applied, oscillations are damped since the initial moment.

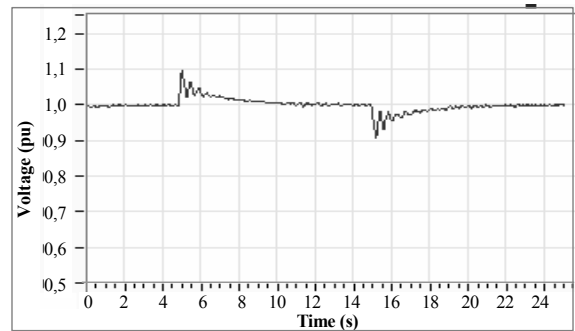

Figure 16 System response due to variation on the power load. Terminal voltage at synchronous generator only with AVR

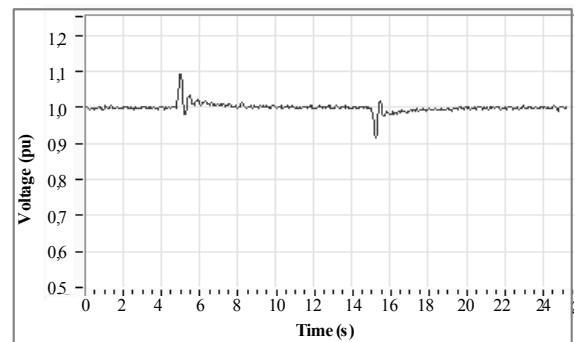

Figure 17 System response due to variation on the power load. Terminal voltage at synchronous generator with adaptive PSS

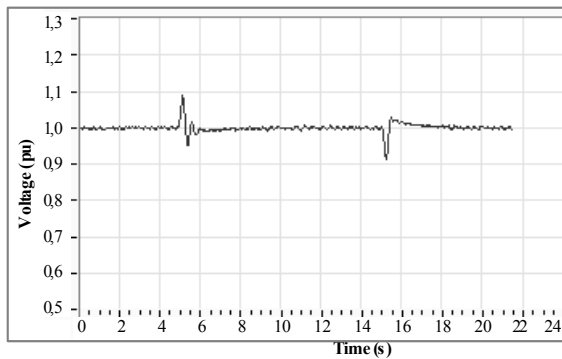

Figure 18 System response due to variation on the power load. Terminal voltage at synchronous generator with Neural based PSS

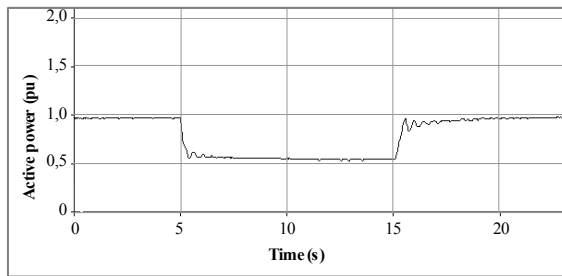

Figure 19 System response due to variation on the power load. Terminal active power at synchronous generator only with AVR

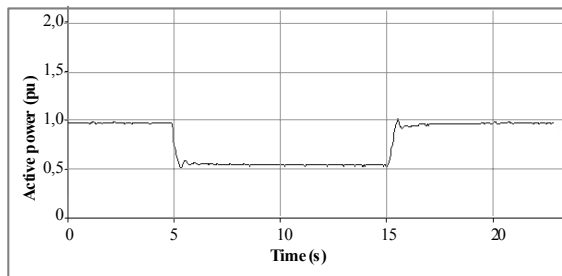

Figure 20 System response due to variation on the power load. Terminal active power at synchronous generator with adaptive PSS

Test type 3: Three phase short circuit

To verify the performance of the neural based PSS during transient conditions, the synchronous generator was tested by applying three phase

short circuit at machine terminals, through a fault resistance of 2Ω .

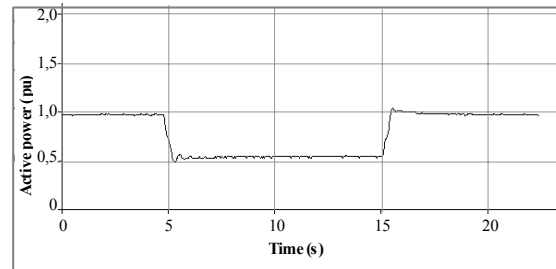

Figure 21 System response due to variation on the power load. Terminal active power at synchronous generator with neural based PSS

In this case, the operating point is at 75% of its nominal capacity. Three short circuits successively are caused and cleared at five, 15 and 25 seconds.

According to the observed performance, the system which uses only AVR presents a high oscillatory behaviour and takes near to four seconds to reach the steady state after fault is cleared. It is important to notice the effect of the negative feedback of the AVR loop which increases the oscillations and thus the use of a PSS is needed to damp them, as it is here presented.

Considering the synchronous machine working with an adaptive PSS, the response has the similar setting time but presents soft decreasing and reduced signal oscillations. The neural based PSS shows a sudden over voltage and the time to reach steady state condition is also similar to the previous discussed case.

The terminal voltages for each one of the compared schemes, during a three phase short circuit are presented in figures 22, 23 and 24. Figure 24, which corresponds to the machine using PSS, shows reduction in voltage oscillations after a three phase short circuit in the machine terminals. The proposed neural based PSS helps the synchronous machine to obtain the steady state faster than the other schemes currently used. In figures 25, 26 and 27 the active power measured in the different schemes compared is shown. It is notice a lower oscillatory behaviour in case of machine using neural based PSS.

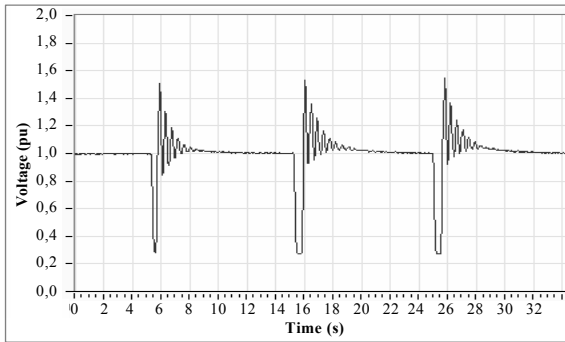

Figure 22 System response due to three phase short circuits. Terminal voltage at synchronous generator only with AVR

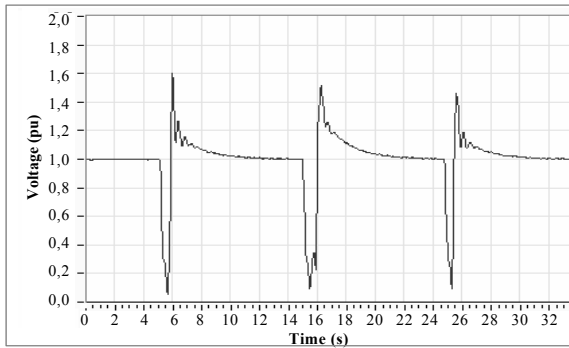

Figure 23 System response due to three phase short circuits. Terminal voltage at synchronous generator with adaptive PSS

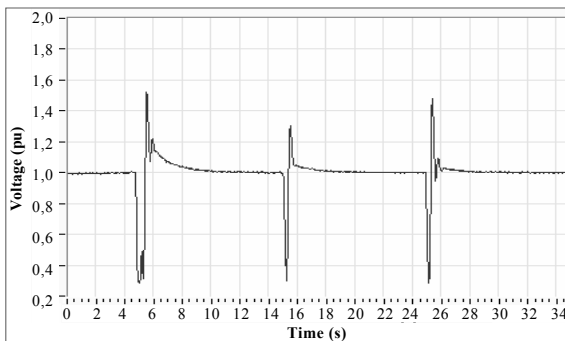

Figure 24 System response due to three phase short circuits. Terminal voltage at synchronous generator with neural based PSS

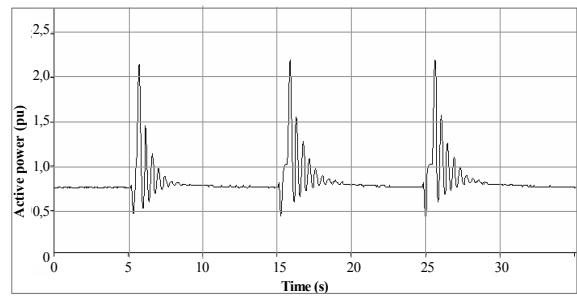

Figure 25 System response due to three phase short circuits. Terminal active power at synchronous generator only with AVR

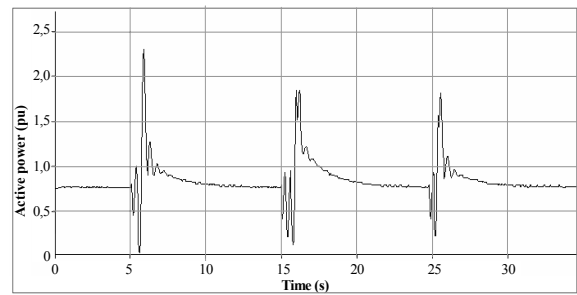

Figure 26 System response due to three phase short circuits. Terminal active power at synchronous generator with adaptive PSS

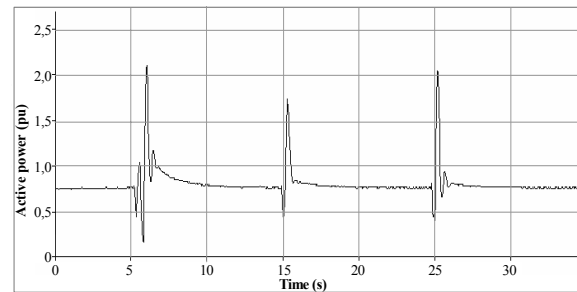

Figure 27 System response due to three phase short circuits. Terminal active power at synchronous generator with neural based PSS

Conclusions

A neural based PSS is proposed as alternative to reduce magnitude and duration of the transient oscillations caused by external perturbations as variations in the reference voltage and load.

The followed strategy is based on training a neural based PSS by using data obtained from an adaptive PSS. Next, the pre-trained neural based PSS is updated by using a modifier neural net. The latter helps to determine the behaviour of the synchronous machine by obtaining the adequate value of the control signal required to assure a desired voltage terminal. Results obtained by testing the proposed strategy in a synchronous machine laboratory show the better performance of the neural based PSS than traditional approaches as adaptive PSS. This is mainly due to: a) online identification is no used by the neural based PSS causing a fastest response than the adaptive, and b) the supplementary training applied to the neural based PSS by using the modifier net.

References

1. K. S. Narendra, K. Parthasarathy. "Identification and control of dynamical systems using neural networks". *IEEE Trans. Neural Networks*. Vol. 1. 1990. pp. 4-27.
2. P. Shamsollahi, O. P. Malik. "Direct Neural Adaptive Control to synchronous generator". *IEEE Trans. On energy conversion*. Vol. 14. 1999. pp. 1341-1346.
3. P. Shamsollahi, O. P. Malik. "Application of neural adaptive power system stabilizer in a multi-machine power system". *IEEE Trans. On energy conversion*. Vol 14. 1999. pp. 731-736.
4. P. Shamsollahi, O. P. Malik. "Real-time implementation and experimental studies of a neural adaptive power system stabilizer". *IEEE Trans. On energy conversion*. Vol. 14. 1999. pp. 737 - 742.
5. W. Liu, G. Venayagamoorthy, D. Wunsch. "Adaptive neural network based power system stabilizer design". *IEEE Trans. On energy conversion*. 2003. pp. 2970-2975.
6. K. Prabha. *Power System Stability and Control*. New York: McGraw-Hill, 1994.
7. S. Pérez, J. Mora, G. Olguin. "Maintaining voltage profiles using an adaptive PSS". *Transmission & Distribution Conference and Exposition: Latin America, 2006*. TDC apos. 06. IEEE/PES Volume 1. 2006. pp. 1-5.
8. P. Shamsollahi, O. P. Malik, "On-line identification of synchronous generator using neural networks," in *Proc. Can. Conf. Elect. Comput. Eng.* 1996. pp. 595-598.
9. R. Wankeue, I. Kanwa, X. Dai-Do, A. Keyhani. "Iteratively reweighted least square for maximum likelihood identification of synchronous machine parameters from on line tests". *IEEE Trans. Energy Conversion*. Vol. 14. 1999. pp.159-166.
10. G. Goodwin, K. Sang. *Adaptive filtering prediction and control*. Prentice - Hall. New Jersey. 1984. pp.125-134.
11. S. Pérez. *Control de Oscilaciones de la Máquina Síncrona utilizando un Estabilizador Neuronal*. M.Sc thesis, Universidad Tecnológica de Pereira, Pereira, Risaralda, Colombia, 2005. pp. 12-86.