

The negative sequence impedance as fault indicator in induction motors

La impedancia de secuencia negativa como indicador de falla en motores de inducción

Fernando Villada^{1*}, *Diego Raúl Cadavid*¹, *José Edinson Aedo*², *Bernardo Andrés Benavides*², *Esteban Velilla*¹

¹Group of Efficient Energy Management – GIMEL, Universidad de Antioquia, A.A. 1226, Medellín, Colombia

²Group of Microelectronics and Control, Universidad de Antioquia, A.A. 1226, Medellín, Colombia

(Recibido el 20 de febrero de 2009. Aceptado el 10 de agosto de 2009)

Abstract

An algorithm to detect inter-turn faults in induction motors based on the negative sequence impedance is presented in this paper. The implementation through a digital prototype is also explained and its results are tested using a 3 Hp induction motor designed to induce inter-turn faults. It is concluded that the robustness of the algorithm can detect incipient faults from five turns, and it is a good tool for predictive maintenance of induction motors.

----- *Keywords:* Induction motors, stator fault diagnosis, negative sequence impedance, digital signal processing (DSP)

Resumen

En este trabajo se presenta un algoritmo basado en la impedancia de secuencia negativa para detectar fallas entre espiras de los motores de inducción, se explica su implementación en un prototipo electrónico de diagnóstico y sus resultados se verifican experimentalmente en un motor de 3 Hp, el cual se acondicionó para realizar fallas entre espiras. Se concluye que es útil como parámetro de diagnóstico al poder detectar fallas incipientes a partir de cinco espiras en cortocircuito, mostrando ser una buena herramienta para el mantenimiento predictivo de los motores eléctricos de inducción.

----- *Palabras clave:* Motores de inducción, diagnóstico de falla en estator, impedancia de secuencia negativa, procesamiento digital de señales

* Autor de correspondencia: teléfono: + 57 + 4 + 219 85 59. fax: + 57 + 4 + 211 05 07, correo electrónico: fvillada@udea.edu.co (F. Villada).

Introduction

Induction motors are vital components of many processes. They are the most common driving devices used today because of their robustness, low cost, easy maintenance and versatility with applications ranging from home devices to sophisticated industrial equipment. Nevertheless, these motors have limitations and if they are exceeded, a premature fault in the stator or the rotor will result. One of these faults occurring in the stator is the inter-turn short circuit, which begins with a small amount of turns ending with a catastrophic failure [1]. One of today ways to get information from the machine is the use of voltage and current sensors due to their low cost and non invasiveness. Many diagnosis techniques have been proposed in the last years to detect inter-turn faults in induction motors, e.g. stator current analysis, axial leakage flux, negative sequence impedance, electromagnetic torque, and application of artificial intelligence techniques.

Stator current analysis has been used to diagnosis rotor bar faults but it has limitations in the detection of stator inter-turn short circuits [2]. Axial leakage flux, negative sequence impedance and electromagnetic torque have shown sensitiveness to stator winding faults but they have some difficulties with the numerical integration required and the instability of these variables [3].

As an alternative to this inconvenience and the need of mitigating the dependence of experts for the analysis, the diagnosis problem has been recently boarded using artificial intelligence techniques [4-5]. Awadallah [4] shows a complete revision of online maintenance methods of induction motors proposing possible applications through artificial intelligence. A new artificial neural network-based algorithm, explaining the process of obtaining the training data, the training process, the neural network results and the implementation in the laboratory is discussed in [5]. The algorithm was able to detect incipient faults from five inter-turn short circuits in most

of the tests. The negative sequence impedance method has shown some advantages because this impedance keeps approximately constant for different load conditions. Nevertheless, Cabanas [3] explains a series of difficulties for its implementation in digital circuits given the low value of the current I_n , which causes sudden changes in the calculation of the variable. Furthermore, the effectiveness of the method is questionable under supply unbalance conditions.

Positive and negative sequence third harmonics of the line current under supply unbalance and different operating conditions by combining space and time harmonics are presented in [6]. The suggested fault signature was obtained by removing residual components from tested quantities. Simulation and experimental results using one second of data indicate that the proposed third harmonic signatures are capable of very effectively detecting inter-turn faults and distinguish them from voltage unbalance and structural asymmetry.

The application of the Prony's method to calculate the fundamental positive and negative sequence components of voltage and current of induction motors is proposed in [7]. The fundamental sequence component figured out by using the Prony's method is put into a neural network to calculate the indicator for diagnosis. The validity of the scheme is verified by experimental results on a 3 kW three-phase induction motor.

Condition monitoring is produced online in the real world. For this reason, it is necessary to implement electronic devices to sense the signals of interest and process them to obtain health information from the machine. Digital signal processors (DSP) are one of these devices which have been widely used to implement online monitoring algorithms.

A deeper study of the negative sequence impedance algorithm to diagnose stator faults on induction motors is presented in this paper. The problem of implementation is faced through a digital prototype using a DSP. First, a method to calculate the negative sequence impedance is

described. Second, the general architecture of the implemented digital equipment is explained. Finally, experimental results on a 3 Hp induction motor with internal tapings to force inter-turn short circuits in the stator winding are presented.

The negative sequence impedance

The negative sequence impedance is obtained from the sequence components of voltage and current of an induction motor, which are given by [8]:

$$\begin{bmatrix} V_p \\ V_n \\ V_o \end{bmatrix} = \begin{bmatrix} Z_{pp} & Z_{pn} & Z_{po} \\ Z_{np} & Z_{nn} & Z_{no} \\ Z_{op} & Z_{on} & Z_{oo} \end{bmatrix} * \begin{bmatrix} I_p \\ I_n \\ I_o \end{bmatrix} \quad (1)$$

Where the terms p, n, and o, denote the positive, negative, and zero sequence of the voltage and current phasors, respectively. Z_{ij} represents the sequence impedance i originated by the sequence j . As an industrial induction motor is fed by a three-phase system without neutral, the zero sequence current, I_o , is zero, and equation (1) is reduced to:

$$\begin{bmatrix} I_p \\ I_n \end{bmatrix} = \begin{bmatrix} Z_{pp} & Z_{pn} \\ Z_{np} & Z_{nn} \end{bmatrix}^{-1} * \begin{bmatrix} V_p \\ V_n \end{bmatrix} \quad (2)$$

From equation (2), I_n changes with the power supply variations, the motor asymmetries and the load. As an inter-turn fault occurs, the matrix impedances changes because the motor will be asymmetrical. In this way, the fault can be detected from the changes of the current I_n or the sequence impedances. In a previous work, a diagnostic method based on the negative sequence current combined with an artificial neural network was proposed [5]. In this paper, the implementation of the negative sequence impedance in a DSP and its performance with stator winding faults is analyzed.

The complex negative sequence impedance is calculated by equation (3):

$$Z_2 = \frac{V_n}{I_n} \quad (3)$$

Where, Z_2 is the negative sequence impedance.

This impedance shows some advantages over other methods because it is practically independent of the motor speed and is sensitive to small amounts of inter-turn short circuits as it is shown in the experimental tests.

Implementation of the negative sequence impedance method in a digital prototype

The implementation of the algorithm supposes a sinusoidal power supply. Nevertheless, the power network is contaminated with harmonics in the real world, being necessary the use of signal processing techniques such as the Fast Fourier Transform (FFT). In this work, FFT is applied to extract the fundamental components of voltage and current in order to calculate the negative sequence impedance.

The architecture of the implemented equipment is illustrated in figure 1 with the next main components:

- Current sensors.
- Voltage sensors.
- Signal conditioning system.
- Digital signal processor (DSP).
- RAM memory.
- Personal computer (PC).

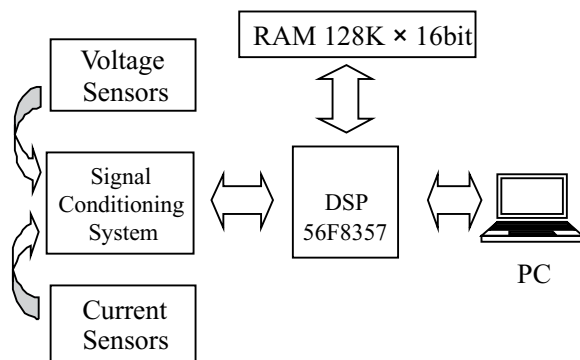

Figure 1 Block diagram of the implemented equipment

Current sensors

Current clamps are used to sense the electric current. The prototype allows the use of different transformation levels: 1 mV/A, 3 mV/A, 10 mV/A, 12 mV/A, 100 mV/A y 400 mV/A. Other relations can be obtained by a previous calibration.

Voltage sensors

A special circuit using a resistive voltage divisor was designed to sense the voltage signals. The circuit uses *Analog Devices* operational amplifiers AD202 [9] and a general purpose operational amplifier OP777. The operation of the circuit is as follows: the resistive divisor (Resistances R2 and R3 in figure 2) attenuates the magnitude of the input voltage to a value in the maximum input range of the insulation amplifier (10Vpp). The insulation amplifier uses a non-inverse configuration with unitary gain, which gives the required galvanic insulation to separate the ground of the prototype from the ground of the induction motor. Finally, the voltage signal passes through a OP777 device, which works as a buffer to couple the impedances of the next conditioning stage. It must be highlighted that the AD202 device gives a galvanic insulation of 2000 Vpp. It also introduces a maximum distortion of 0.25% in the sensed signal and its bandwidth is 2000 Hz. Figure 2 shows the voltage sensing circuit.

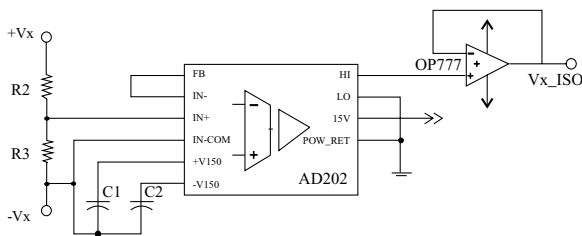

Figure 2 Voltage sensing circuit

Signal conditioning

The signal conditioning system allows the capture of the voltage and current signals and adjust them to be processed by the analog to digital converter

(ADC) embedded in the DSP. The conditioning system is basically composed by a low-pass filter bank, variable gain amplifiers, a level shifter, transducers, and over voltage protection circuits. The main characteristics of the signal conditioning system are:

- Three analogue capture channels for the voltage signal in the input range from 100 to 440 VRMS.
- Three analogue capture channels for the current signal in the input range from 0 to 50 ARMS.
- Low-pass filters with cut-off frequency digitally configured by the DSP. The cut-off frequency can be linearly adjusted between 100 Hz and 64 Hz.
- Gain amplifiers digitally configured by the DSP. Each channel gain can be linearly adjusted between 0.1 and 10.1 in steps of 0.04.
- A 12 bits ADC.

Figure 3 shows the block diagram of one channel conditioning system.

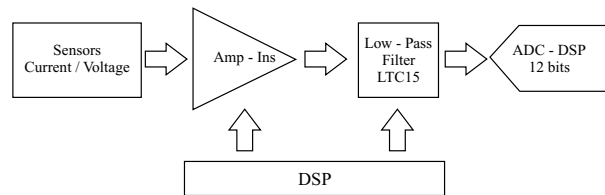

Figure 3 Conditioning system block diagram

Digital signal processor

A 16 bit DSP of the Freescale 56F8300 family is used as data processing unit [10]. This family combines the versatility of a standard DSP with a variety of modules inside one microcontroller. Some of the modules are: 12 bits ADC, two serial ports, two PWM with six channels per module, four timers with four channels per module, and two timers with two channels per module which allow synchronizing with the ADC. The functions of the DSP are:

- To setup the gain of the analogue channels according to their previous calibration.
- To setup the anti-aliasing filters cut-off frequency located in the conditioning system.
- To calculate the sequence components and the negative sequence impedance from the phase magnitude and phase angle.
- To setup the sample frequency to capture the voltage and current signals.
- To calculate the magnitude and angle of the fundamental component for each of the three voltages and currents signals from the process captured data.
- To establish communication with the PC. The DSP receives the configuration parameters from the PC and send the corresponding results according to the PC requirements.

RAM Memory

The DSP internal memory is not enough to process the data and calculate the required transformations. An external memory module of 128 K x 16 bits is required to solve the problem to allow data processing. In this way, it is possible to calculate the FFT as long as 4096 points for each of the three voltage and current signals.

The final assembly of the prototype is shown in figure 4.

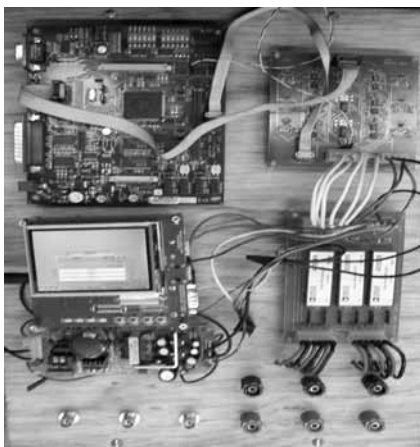

Figure 4 Assembly of the electronic prototype

Experimental results

A 3 Hp induction motor with the characteristics shown in appendix 1 was used to test the algorithm of the negative sequence impedance implemented in the DSP. The motor has derivations in the stator winding to induce inter-turn short circuits. The measured negative sequence impedance for the healthy motor was stable as shown in figure 5. Then inter-turn faults covering 5, 7, and 14 turns were carried out and the results are shown in figures 6, 7, and 8. It is important to clarify that the fault current was limited using a low value resistance of 0.088 W in order to avoid a catastrophic failure in the winding during the execution of the tests. The figures show the sensitivity of the algorithm for the described level of failures with a stable value of the implemented variable for each of the shown tests. Table 1 shows that the percentage change of the variable goes from 9.5% to 76% for a fault covering from 5 to 14 turns in the stator winding.

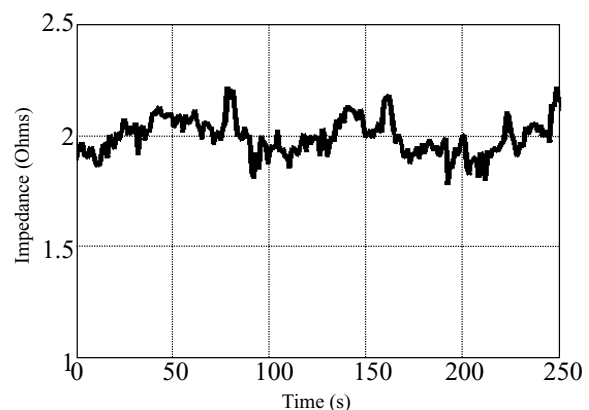

Figure 5 Negative sequence impedance $Z(-)$ for a healthy motor

Despite the induction motor used in the tests was protected using resistances to limit the fault current, it is clear the sensitivity of the negative sequence impedance with the number of the inter-turn short circuits. It can be inferred that for real faults, which have no limiting resistances, stator winding faults covering a lower number of turns could be detected. It is concluded that the great potential of the electronic prototype can reliably

detect incipient faults in the stator winding for as short as 5 turns independently of the motor size.

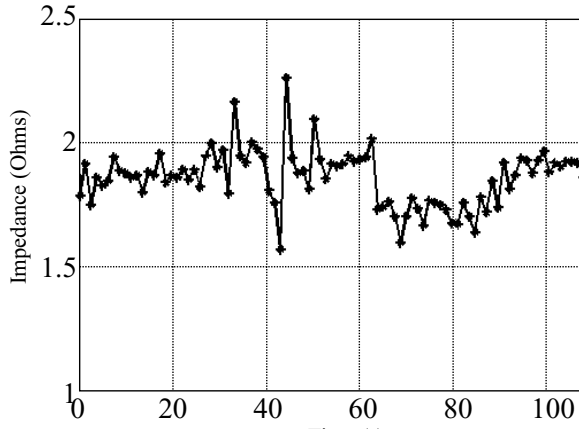

Figure 6 $Z(-)$ for 5 inter-turn stator fault at the time of 62 seconds

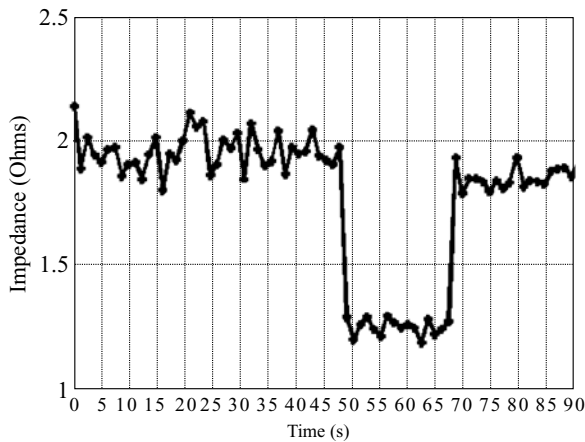

Figure 7 $Z(-)$ for 7 inter-turn stator fault at the time of 47 seconds

Conclusions

An algorithm based on the negative sequence impedance to diagnosis stator faults in induction motors was presented in this paper. Moreover, a detailed explanation of its implementation in a digital prototype using a DSP minimizing the stability problems reported in previous works was explained. The general structure of the prototype and the experimental results in a test bench conditioned for this purpose were also shown. The feasibility of the method and the robustness of the

implemented algorithm which is able to detect incipient faults in induction motors from five short circuit turns is concluded. This demonstrates the potential to develop new cost competitive equipment with great industry applicability in comparison with imported products.

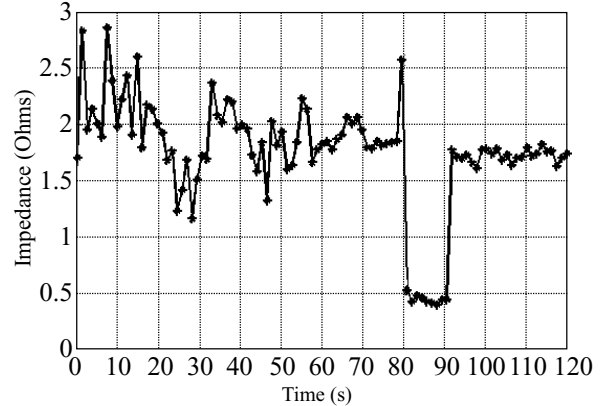

Figure 8 $Z(-)$ for 14 inter-turn stator fault at the time of 79 seconds

Table 1 Negative sequence impedance changes with the number of faulted turns

Number of faulted turns	$Z(-)$ before the fault	$Z(-)$ after the fault	$Z(-)$ % change
0	1.9926	—	—
5	1.8959	1.7155	9.52 %
7	1.9108	1.2432	34.94%
14	1.8733	0.4444	76.28%

References

1. J. Ilonen, J. Kamarainen, T. Lindh, J. Ahola, H. Kalviainen, J. Partanen. "Diagnosis Tool for Motor Condition Monitoring." *IEEE Transactions on Industry Applications*. Vol. 41. 2005. pp. 963-971.
2. H. Henao, C. Martis, G. A. Capolino. "An Equivalent Internal Circuit of the Induction Machine for Advanced Spectral Analysis." *IEEE Transactions on Industry Applications*. Vol. 40. 2004. pp. 726-734.

3. M. Fernández Cabanas, M. García, G. A. Orcajo, J. Cano, J. Solares. *Maintenance and Diagnostic Techniques for Rotating Electric Machinery*. Ed. Marcombo. Barcelona. 1999. pp. 251-307.
4. M. A. Awadallah, M. M. Morcos. "Application of AI tools in Faults Diagnosis of Electrical Machines and Drives-An Overview." *IEEE Transactions on Energy Conversion*. Vol. 18. 2003. pp. 245-251.
5. F. Villada, D. Cadavid. "Diagnóstico de fallas en motores de inducción mediante la aplicación de redes neuronales artificiales." *Información Tecnológica*. Vol. 18. 2007. pp. 105-112.
6. J. Sottile, J. L. Kohler. "An On-line Method to Detect Incipient Failure of Turn Insulation in Random-wound Motors," *IEEE Transaction on Energy Conversion*. Vol. 8. 1993. pp. 762-768.
7. Q. Wu, S. Nandy. "Fast Single-turn Sensitive Stator Inter-turn Fault Detection of Induction Motors based on Positive and Negative Sequence Third Harmonic Components of Line Currents". *IEEE Industry Applications Society Annual Meeting*. Edmonton. Canadá. 2008. pp. 1-8.
8. F. Fang, S. Yang, X. Hou, Z. Wu. "Application of the Prony's Method for Induction Machine Stator Fault Diagnosis". *International Conference on Electrical Machines and Systems ICEMS*. Wuhan. China. 2008. pp. 827-831.
9. Low Cost Miniature Isolation Amplifiers AD202-204. *Data Sheet Rev D*. 10/2002.
10. MC56F8367. *Preliminary Technical Data, Rev. 4.0*. Freescale Semiconductor, Inc. 2005.

Appendix Characteristics of the test bench

Induction motor

Power = 3 Hp
 V = 220 Vrms, f = 60 Hz
 P = 4
 J = 0.04 kg.m²
 N = 102 turns per each parallel way
 Xs = 1.5068 Ω
 Xr = 1.5068 Ω
 Xm = 27.810 Ω
 Rs = 0.720 Ω
 Rr = 0.7817 Ω